

1.

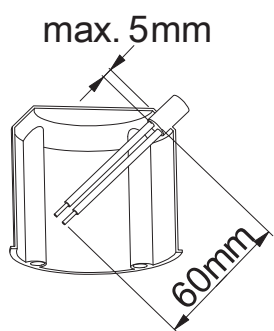

2.

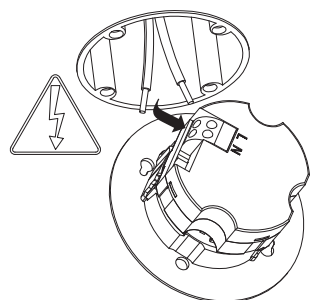

Art.-Nr./Item no./N° d'Art. 670632-V02

3.

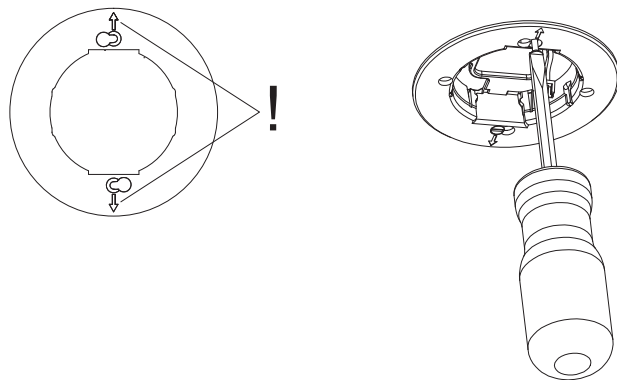

4.

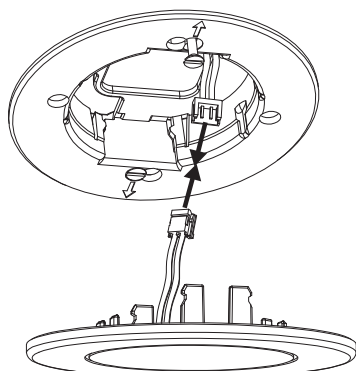

5.

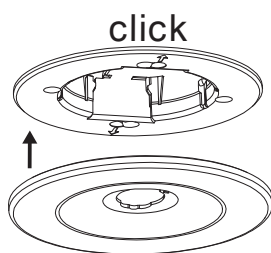

6.

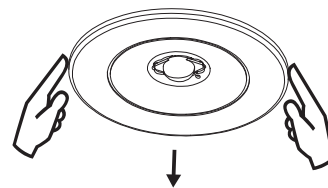

7.

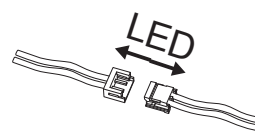

8.

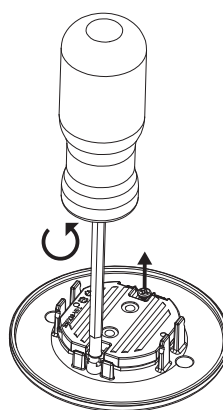

9.

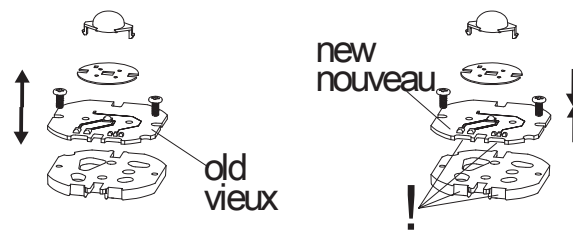

10.

8. → 4. → 5.

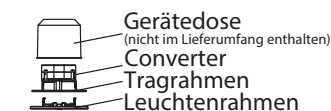
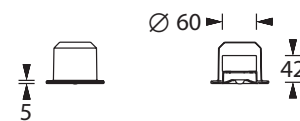

Deckenaufbaugehäuse



Kabeleinführung

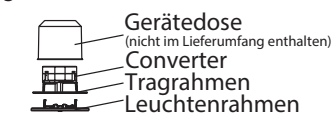
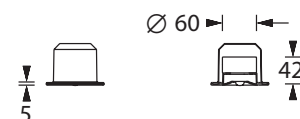
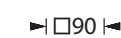







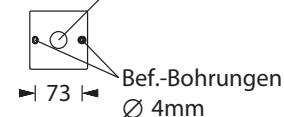













Deckenaufbaugehäuse



Kabeleinführung



- | | |
|---|---|
|  Gerätedose ¹⁾ |  Converter |
|  One-Gang-Box ¹⁾ |  Converter |
|  Prise d'appareil ¹⁾ |  Convertisseur |
|  Tragrahmen |  Leuchtenrahmen |
|  Steel frame |  Luminaire covers |
|  Châssis porteur |  Châssis de lampes |
|  Gehäuse für Deckenaufbau ¹⁾ |  Kabeleinführung |
|  Housing for ceiling mounting ¹⁾ |  Cable entry guide |
|  Boîtier pour montage au plafond ¹⁾ |  Introduction de câble |
|  Bef. Bohrungen | |
|  Existing boreholes | |
|  Perçages existants | |

¹⁾ nicht im Lieferumfang enthalten
¹⁾ not included in the delivery
¹⁾ pas inclus dans la quantité livrée

